

Family car three guarantees certificate

Warranty certificate number/vehicle identification code (a):	
product information:	
product brand:	Vehicle type (b):
Vehicle specification (b):	Model:
Production Date:	
manufacturer information	
name:	address:
Zip code:	customer service hotline:
ZEEKR service (experience) center information	
name:	address:
Zip code:	telephone number:
Sale date:	Delivery date:
Date of purchase invoice:	ZEEKR service (experience) center stamped (valid only after stamped):
Three Guarantees	
Vehicle warranty period: 48 months or 100,000 kilometers (whichever comes first).	Validity period of the three guarantees for the vehicle: 24 months or 50,000 kilometers (whichever comes first).
Please refer to the electronic version of the user manual for the use of compensation coefficients / warranty of parts and wearing parts / power battery capacity attenuation limit. (a): The vehicle identification code is the unique number of the Three Guarantees certificate. (b): see GB/T3730.1-2001, for vehicle types; see GA24.4-2005, for vehicle specifications.	

welcome

Thank you for choosing ZEEKR vehicles with excellent safety, comfort, power and economy.

Before using it for the first time, please read the content of this manual carefully and completely, which will help you better understand and use the vehicle.

All the information in this manual is the latest information at the time of publication, but the company will continue to improve and optimize the product, the vehicle you purchased may be different from the description in this manual, please refer to the actual vehicle received allow.

Please ensure that this manual is kept in the car at all times. Especially when lending or reselling this vehicle to another person, please pass this manual on to the driver or new owner.

If you have any questions or need to make an appointment, please call us at 4000-036-036. You can also drive to the ZEEKR service (experience) center.

Before
arrivin
g,
please
pay
attenti
on to
driving
safety.

Zhejian
g
Jikrypt
on
Intelli
gent
Technol
ogy
Co.,
Ltd.

前言

本手册相关的重要信息.....	9
敬告用户.....	10
联系ZEEKR极氪.....	10
事件数据记录系统.....	10
电子用户手册.....	11
使用经认证的纸张.....	11

安全出行

安全系统.....	15
安全带.....	15
使用安全带.....	16
安全气囊.....	18

启动和驾驶

指示灯和警告灯.....	25
车身稳定控制系统.....	28
制动防抱死系统.....	29

高压系统

高压警告标签.....	33
应急救援信息.....	34
充电安全警告.....	36

紧急情况下

紧急救援.....	39
-----------	----

应急解锁和锁止车门.....	39
应急解锁充电枪.....	41
应急解锁充电口盖.....	42
牵引车辆.....	44
安全背心和三角警示牌.....	45

技术资料

车辆标识.....	49
胎压标签.....	50
车辆参数.....	51

foreword

Important information related to this manual

Zhejiang Jikrypton Intelligent Technology Co., Ltd. recommends that you read this manual carefully before using the vehicle for the first time. In order to better understand the contents of this manual, you need to know all the following information.

prompt information



personal injury

The warning sign reminds you: Failure to follow the warning content may cause personal injury or even life-threatening to you or others.



risk of vehicle damage

The attention mark reminds you: Failure to follow the precautions may result in vehicle damage.



help information

Here you can find some helpful hints or useful details.

Icons and Illustrations

The illustrations in this manual are general pictures and are intended to aid in your understanding by showing some features or functions of the vehicle to aid in the explanation. The illustrations in this manual are for reference only, please refer to the actual vehicle for specific conditions.



This icon means "don't do this" or "don't let this happen".



This icon means "recommended" or "may allow this to happen".



If an illustration shows multiple parts, this icon indicates the part location.



If an illustration contains more than two actions, this icon indicates the sequence of moves/actions involved.



If an illustration contains only one action, this icon indicates movement/action.

display text

The text or message displayed on the vehicle display is formatted differently from normal text (eg: cancel, system reset, route editing, etc.), procedures and instructions are displayed in multiple steps (eg: vehicle function settings - driving - handling & vision) .

Vehicle configuration and options

This brochure also provides information on the various modules, standard equipment and optional features in the model series. You may

find that some of the information is not applicable to your model, because the specific configuration will be different according to the laws and regulations of different markets and different countries or regions. For details, please refer to the actual configuration of the vehicle.

You can identify equipment on your vehicle by the available controls, switches, buttons, decals, icons and menu options. Features may also be added, removed, or changed by updating the software. If you have any questions, please contact ZEEKR partners.

Warn users

For your safety, please be sure to abide by local laws and regulations when driving a vehicle, and follow the following precautions:

As the vehicle is continuously updated, the electronic user manual will also be updated accordingly, so the content of the electronic user manual may be different from the paper user manual attached to the vehicle, please refer to the electronic user manual.

You should maintain a sober driving state at all times, and do not drive the vehicle under unsuitable driving conditions such as drinking, taking drugs or feeling unwell, otherwise it will affect your control of the vehicle and observation of the surrounding conditions, which may cause accidents and cause casualties or property damage.

Please drive carefully, accurately judge whether the weather and road conditions are suitable for travel, and pay attention to the movements of other vehicles or pedestrians on the road at any time, so as to make accurate and timely judgments and prevent accidents.

Please keep your full attention while driving. Do not take your hands off the steering wheel for a long time. Answering calls, checking text messages or adjusting control buttons during driving will distract your attention, which may lead to accidents, casualties or property damage.

Please read the relevant warnings and precautions in this manual carefully, ignoring these contents may cause personal injury or property damage (including vehicle damage) to drivers and passengers.

If you have any questions about the content of this manual, please contact ZEEKR through the following methods.

ZEEKR partner
Customer Service Hotline: 4000-036-036

Contact ZEEKR

ZEEKR extreme krypton
<https://zeekrlife.com>

Event Data Recording System

ZEEKR vehicles are equipped with an event data recording system (EDR), which is used to record information related to vehicle collisions, such as the vehicle's driving speed (the signal is obtained from the chassis controller and the sensor, indicating the vehicle's speed at the time of the incident), and Active state (indicating whether the vehicle is braking at the time of the event). For the meaning and use of the specific record data items, see the 17 data elements and descriptions of the A-level data elements in Table 2 in the GB39732-2020 "Automobile Event Data Recording System" standard.

When a collision event occurs to a vehicle, the current event data can overwrite the previous non-locking event data according to the time sequence in which the accident data is stored.

Event data information can help relevant personnel understand the status of the vehicle when the event occurs, so that ZEEKR can act in accordance with relevant legal requirements and other regulations. In addition, this information can also be used for engineering research, which will help ZEEKR continue to improve product quality and safety.

According to the requirements of national laws and regulations, ZEEKR may need to disclose relevant recorded data to certain regulatory agencies (such as public security organs or other

agencies that have access to the event data recording system). Reading the data in the event data recording system may require the use of ZEEKR vehicle-specific data reading equipment, which is connected to the vehicle OBD interface or separately connected to the EDR controller for extraction through special equipment. Krypton Service (Experience) Center is used. The way to obtain the data reading device: If necessary, you can contact the ZEEKR authorized dealer and apply to the manufacturer for the device with their assistance.

Electronic User Manual

The on-board paper user manual contains some selected information during your use, and you can view the electronic user manual for complete information. In addition, the electronic user manual also provides you with more functions, such as video, search, content feedback, etc. You can view the electronic user manual in any of the following ways:

- 1 View the electronic owner's manual via the center display
Click the Apps-User Manual icon on the central display to enter the electronic user manual interface.
- 2 View the electronic user manual through the ZEEKR App
Click the user manual icon on the car page of ZEEKR App to enter

the electronic user manual interface.

①Explanation!

As the vehicle is continuously updated, the electronic user manual will also be updated accordingly, so the content of the electronic user manual may be different from the paper user manual attached to the vehicle.

ZEEKR reserves the right to change the user manual at any time.

Use certified paper

ZEEKR is extremely concerned about environmental protection issues, and the paper used in the paper version of the user manual is from reliable sources. This publication is certified by FSC and is in line with the beautiful vision of "leaving greenery for future generations".

You can see the Forest Stewardship Council (FSC®) logo, which indicates that the paper used in this publication comes from FSC-certified forests.



travel safely

security system

The safety system consists of multiple safety devices that work

together to protect you and your passengers in the event of an accident. Depending on the situation, different safety devices will be activated.

- seat belt
airbag

If one or more airbags are triggered or if the seat belts are triggered, the doors will automatically unlock, facilitating the escape of occupants and rescuers. At the same time, the vehicle cuts off the high-voltage system to avoid high-voltage leakage. If you need to restore the high-voltage system, it is recommended to contact the ZEEKR service (experience) center for maintenance.



The safety system cannot avoid all possible injuries in traffic accidents, nor can it detect and eliminate all risks during driving. Please drive the vehicle carefully.

After the door is automatically unlocked, please leave the vehicle immediately to reach a safe area, and then call the police or seek help.

Never attempt to repair the vehicle yourself or reset electrical installations after the doors have unlocked automatically.

After any collision with the vehicle, you should promptly contact ZEEKR service (experience) and allow it to inspect.

Notice!

Do not drive or tow the vehicle after the doors are automatically unlocked. The vehicle must be transported to the ZEEKR service (experience) center on a flatbed trailer for inspection and repair. _____

seat belt

The role of seat belts

In the event of a collision, wearing a seat belt correctly can reduce personal injury and protect the head and chest of the occupant from damage.

warn!

Before each trip, each occupant must fasten the seat belt correctly, see Using Seat Belts (page 16).

Each seat belt can only be used by one person, do not share a seat belt with multiple people (including children).

Do not alter, remove or install devices that may change the direction or tension of the seat belt.

After any vehicle collision, you should promptly contact the ZEEKR service (experience) center and allow them to check the seat belt device.

Seat belt not fastened reminder

The seat belt not fastening reminder device is used to remind drivers and passengers to fasten their seat belts before driving. When the vehicle is started and the driver and/or passenger are not fastening their seat belts, the instrument display will illuminate the seat belt not fastened warning light icon.

When the vehicle is running, when the driver and/or passengers are not wearing seat belts and the vehicle reaches a certain speed or mileage, the seat belt not fastening reminder device will also send out a sound reminder signal. After a period of time, the prompt tone will disappear automatically, and the seat belt not fastened warning light icon will appear. Keep on until all the drivers and passengers put on their seat belts. When the vehicle is running and reaches a certain speed or mileage, when the driver and/or occupants loosen the fastened seat belt, the seat belt unfastened warning light icon will light up and an audible reminder will sound. After a period of time, the prompt tone will automatically disappear, and the seat belt not fastened warning light icon will remain on until all drivers and passengers fasten their seat belts.

warn!

When the driver and passengers have fastened their seat belts, but the seat belt not fastened warning light icon is still on, please park the vehicle in a safe place immediately and contact the ZEEKR service (experience) center.

Notice!

Do not place heavy objects on the passenger seat, the system may mistakenly think that the passenger is not wearing a seat belt.

seat belt check

Seat belts are important safety components, please check the following items before driving each time. If there is any abnormality, please contact the ZEEKR service (experience) center immediately.

Check the seat belt for twists and dirt.

Check seat belts for severe wear, cuts, burns.

Insert the seat belt buckle into the buckle until a "click" sound is heard, then pull the lock tongue in the opposite direction to check the fastening of the seat belt buckle.

Pull the seat belt quickly to check the automatic retraction/tensioning of the seat belt.

seat belt cleaning

Please use special seat belt cleaner and sponge to clean the seat belt. Please put the seat belt in a cool place to dry thoroughly before use.

警告!

Never use bleach, dyes or chemical solvents to clean seat belts. These materials can seriously impair the fabric properties of the seat belt.

Retractor with preload

In certain types of vehicle crashes (depending on the angle and severity of the crash), the retractor tightens the seat belts to help restrain the occupants of the vehicle.

warn!

After a crash, the retractor becomes hot and may burn your skin.

Prolonged exposure to fumes and dust from detonating retractors may cause skin or eye irritation. If eyes and skin abrasions become infected by dust (smoke), rinse eyes and skin abrasions immediately; if you still feel unwell after washing, seek medical attention immediately.

illustrate!

□After the detonation of the retractor assembly with pre-tightening function, a small amount of dust (smoke) will be released, and there may be a loud noise at the same time .
This is normal and will not cause a fire.

use seat belt

Fasten seat belts

1 Adjust the seat to a suitable position.
2 Slowly pull out the seat belt and insert the tongue into the buckle until you hear a "click".

3 Make the lap belt as low as possible across the crotch.
Make sure the shoulder belt spans the entire length of the shoulder diagonally, across the chest.

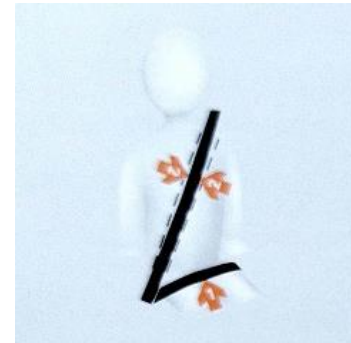

warn!

Do not recline the seat back too far.

Before fastening the seat belt, check whether there are foreign objects (such as: food residues) in the socket of the buckle etc.), if there are foreign objects, please take them out in time.

To ensure that the seat belt works properly, be sure to insert the seat belt into the matching buckle

middle.

When riding, the seat belt must be tightened to prevent loosening, and ensure that it is firm and snug without twisting song.

Never put the seat belt over your back, under your arms or around your neck. The seat belt should stay away from your face and neck, but not over your shoulders.

If the seat belt cannot be used normally, please contact ZEEKR service (experience) center to process.

unfasten seat belt

Press the unlock button on the seat belt buckle and let the seat belt retract on its own.

If the seat belt is not fully retracted, manually assist in retracting it without hanging loose.

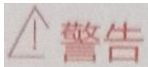

When releasing the seat belt, hold the seat belt before pressing the unlock button to prevent the seat belt from retracting too quickly. _____

safe pregnancy

It is very important for pregnant women to fasten their

seat belts correctly when riding in a vehicle.

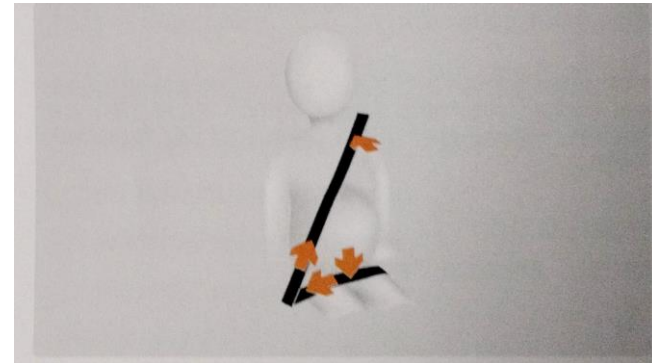

Before a pregnant woman drives a vehicle, consult her doctor about her ability to drive. To reduce the risk of injury to you and your unborn child, the seat should be positioned so that the abdomen is away from the steering wheel, provided that the vehicle can be controlled normally.

travel safely

When pregnant women use seat belts, the shoulder seat belt should go around the shoulders, then around the middle of the chest, to the side of the abdomen. The lap belt should lie flat on the thigh, as low as possible under the abdomen.

⚠ 警告!

Fit the lap belt snugly under your belly bulge.

airbag

The airbag is a passive auxiliary protection device, which is used in conjunction with the seat belt to provide additional protection for the occupant's head and chest.

The airbag unit only operates when the vehicle is started. Seat belts and air bags work together, and if you are not wearing or using your seat belts incorrectly, the protection provided by the air bags in a crash can be reduced or disabled.

The airbag control module monitors the operating conditions of each device, and when the airbag control module detects that a collision event occurs, it controls the deployment of the airbag and the pretensioning of the seat belt. If the safety airbag is deployed during the collision, the airbag will inflate rapidly and expand, and after the inflation is completed, it will deflate and contract in a short time after being squeezed.

Airbag Precautions

When using the vehicle, please always observe the following precautions.

↑ Warning!

Do not install or place any accessories (cup holders, box holders, stickers, etc.) in the location where the airbag is installed.

It is strictly forbidden to modify, disassemble, or install airbags and related components without authorization.

All drivers and passengers must wear seat belts correctly and maintain correct sitting posture. Adults should use seat belts, and younger children should use appropriate child safety seats.

Do not use any electrical test equipment or devices near air bag unit components or electrical components.

The airbag system only provides one-time accident protection. If the airbag is triggered, the airbag unit components must be replaced.

Do not drive the vehicle after the airbag has deployed. Please contact ZEEKR service (experience) center immediately.

Immediately after the air bag deploys, do not touch the interior of the vehicle around the air bag module and the air bag storage area (steering wheel, instrument panel and/or sides of the roof rails).

Prolonged exposure to dust (smoke) from air bag deployment may cause skin or eye irritation. If the eyes and skin abrasions are infected by smoke and dust, please rinse with plenty of water immediately ; if you still feel unwell after washing, please seek medical attention immediately. _____

Airbag Deployment Conditions

Airbags and other safety devices may deploy during certain collisions and impacts, or during vehicle deceleration following a collision, depending on a number of factors, including the magnitude, angle, speed, and object of the impact.

device	Triggering conditions
front airbag	A frontal collision accident occurred, and the safety air The capsule device meets the trigger condition.
side airbag	A frontal/side collision occurs and the safety air The capsule device meets the trigger condition.
head air curtain	A frontal/side collision occurs and the safety air The capsule device meets the trigger condition.

Conditions in which the airbag may not deploy

Whether the airbag deploys or not depends on the specific crash conditions. Vehicle speed, collision angle and collision force are the main determining factors. For example, the airbag may not deploy in the following situations:

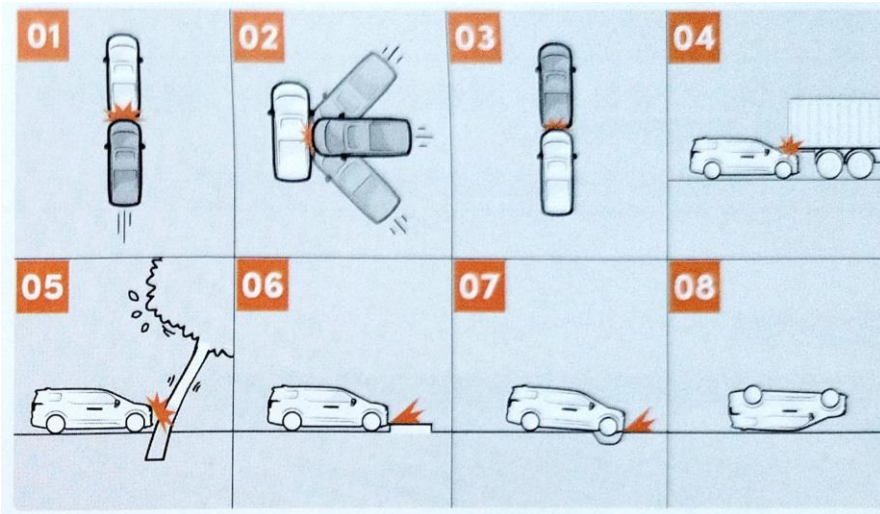

01 When being rear-ended by a vehicle behind.

02 When the vehicle has a side collision.

03 When the vehicle collides with fixed objects (such as vehicles or walls in front) or flexible objects (such as snowdrifts or bushes) at low speed.

04 When the vehicle collides with the container truck or gets into the lower part of the cart.

05 When the vehicle collides with easily deformed objects such as trees.

06 When the vehicle collides with low objects such as steps.

07 When the vehicle suddenly falls into a deep pit or ditch.

08 When the vehicle rolls over.

01

03

04

05

06

07

08

(i) Explanation!

□ The collision points are concentrated in one place (such as: trees or protective poles), and the collision force is not strong enough, the airbag may not be triggered.

The degree of damage to the body structure is not the only factor that determines whether an air bag will trigger.

front airbag

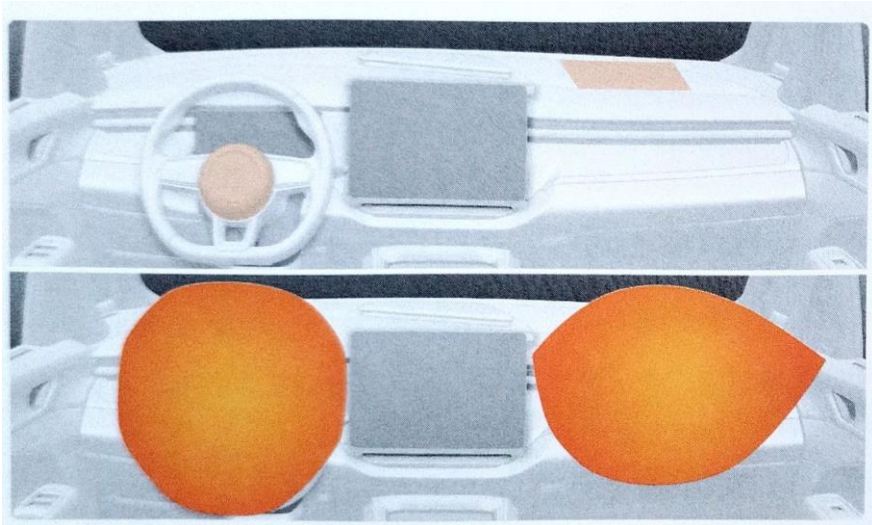

The driver's airbag is installed in the center of the steering wheel, and the word "AIRBAG" is marked on the steering wheel. The airbag on the passenger side is installed above the glove box, and the word "AIRBAG" is marked on the dashboard.

If the front airbags are triggered, the deployed airbags reduce occupant head and chest injuries.

Front side airbags

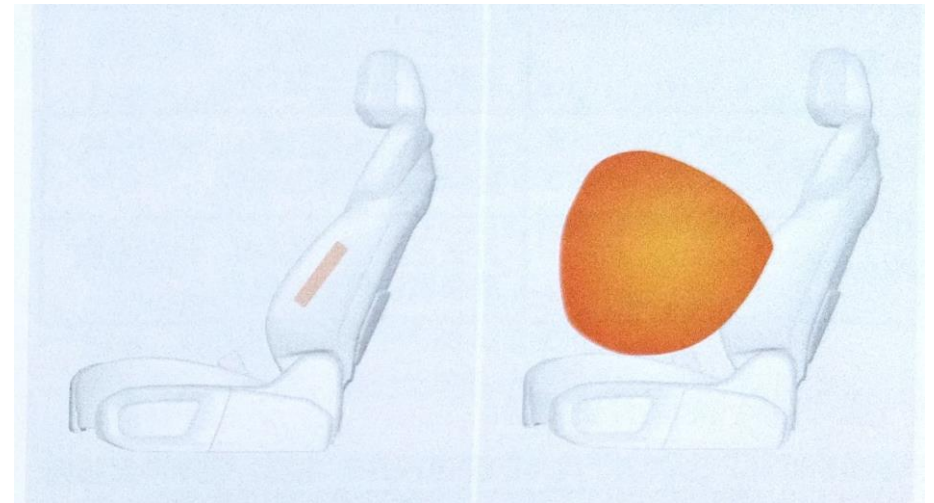

The front side airbags are installed on the outside of the front seats, and the words "AIRBAG" are marked on the seats.

When the vehicle is subjected to a severe lateral impact, the front side airbags are deployed between the occupant and the door trim to protect the occupant's chest, shoulders, and crotch, reducing injuries as much as possible.

warn!

Do not place any objects in the area between the outside of the seat and the door trim.

Never use seat covers on the backrests of the front seats.

head air curtain

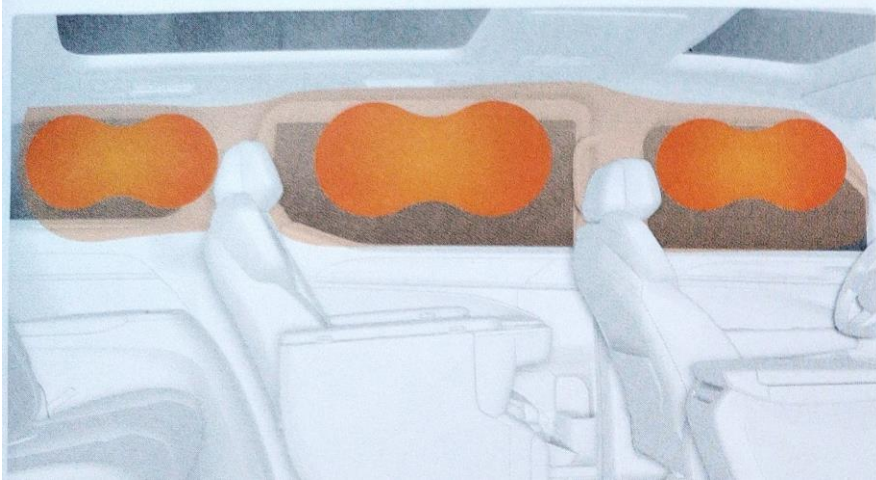

Head curtain airbags are installed along the sides of the roofliner to protect occupants seated on the outer seats. The plaque is marked with "AIRBAG".

In the event of a side and/or frontal collision, the head air curtains deploy to protect your and other passengers' heads from hitting the interior of the vehicle.

警告!

Do not hang or tie heavy objects to the handles on the roof. Coat hooks should only be used to hang light coats and jackets (not hard items such as umbrellas).

Do not place any objects in the air bag deployment area.

Do not install anything on the vehicle roof, door pillars or side trim.

start and drive

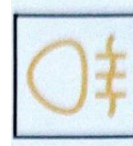

drive
Rear Fog Light Indicator: This light comes on when the rear fog lights are turned on.

Indicator and Warning Lights

light icon

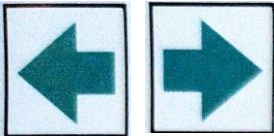

Turn indicator light : When the turn indicator switch is toggled, the corresponding indicator light will flash. When the hazard warning light switch is turned on, both turn indicators flash.



READY indicator light: This indicator light is on when the vehicle is started and the gear is in forward gear (D) or reverse gear (R).



Low beam indicator light : This indicator light is on when the low beam is turned on.

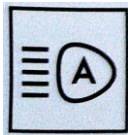

自适应远光灯指示灯: 自适应远光灯开启后, 未激活时, 白色指示灯点亮; 激活后, 远光蓝色指示灯同时点亮。

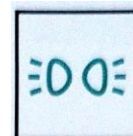

Position Light Indicator : This indicator lights up when the position lights are turned on.



Adaptive Front Lighting Indicator : This indicator comes on when the Adaptive Front Lighting system is on.



Headlight follow-up steering function activation indicator: When the headlight follow-up steering function is activated, the indicator light is on.

High beam indicator light : This indicator light comes on when the high beams are on.



低速行人提示音功能指示灯：低速行人提示音功能关闭时，该指示灯点亮。

One-pedal indicator light : After the One-pedal is turned on, the white indicator light is on when it is not activated; the green indicator light is on when it is activated.

启动和驾驶



Autopark indicator light: This indicator illuminates when Autopark is activated.



Vehicle stability control system off indicator light: This indicator light comes on when the vehicle stability control system is off or the driving mode is switched to sport mode.



Child safety lock indicator light : This indicator light is on when the child safety lock is on.



Slope descent system indicator light : After the slope descent system is turned on, the white indicator light is on when it is not activated; after it is activated, the green indicator light is on.



Hill Descent System Disabled Indicator : When the brake system is overheated, the Hill Descent System is disabled and the indicator light is on.



External charging connection indicator light : After the external charging cable is connected successfully, the indicator light will be on.



Power battery low indicator light : When the power battery is low, the indicator light is on.



Power limit indicator light : This indicator light is on when the vehicle power is limited.



Forward Collision Mitigation Indicator : This indicator comes on when the forward collision mitigation system is off.

warning light icon

WARNING LIGHT ICON INDICATIONS: If the warning light remains on, it indicates that certain important functions have been deactivated or that there is a serious fault with the vehicle which could pose a safety risk. Before driving, make sure the fault is cleared. If you do not know the specific fault, it is recommended to contact the ZEEKR service (experience) center for inspection.

Warning and fault messages are shown on the instrument display. Certain messages are accompanied by an acoustic signal and/or by lighting up the corresponding warning lamp.

Notice!

During normal driving, if the warning light comes on, please stop the vehicle in a safe place immediately and operate according to the prompt information on the instrument display.

 ①Explanation!

□After the vehicle is started, the vehicle will conduct a self-check, and some warning light icons will light up and go out after a period of time. _____



position light fails, the warning light will be on.

Anti-lock braking system malfunction warning light :
If the warning light comes on after the vehicle is started or while the vehicle is being driven, it means that there may be a malfunction in the anti-lock braking system.



Steering system failure warning light : When the yellow warning light is on, the performance of the power steering system is weakened; if the red warning light is on, the power of the power steering system is disabled.



Adaptive high beam failure warning light : This warning light comes on when the adaptive high beam system fails.



High beam failure warning light : This warning light will be on when the high beam fails.

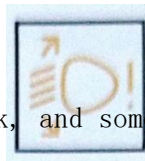

Headlight height automatic adjustment function failure warning light: When the headlight height automatic adjustment function fails, the warning light will be on.



Position light failure warning light : When the

Adaptive front lighting system malfunction warning light: This warning light comes on when the adaptive front lighting system malfunctions.



Tire pressure monitoring system failure warning light : When one or more tires have low tire pressure, the warning light will be on steadily. When the tire pressure monitoring system fails, the warning light will flash and then stay on.



Brake system failure warning light : When the brake fluid level is low, the brake fluid level sensor is faulty, or the electronic brake force distribution function is faulty, the red warning light is on; when the brake system is faulty, the yellow warning light is on.



Low beam failure warning light : This warning light will be on when the low beam fails.

27

Parking automatic emergency braking system failure warning light: When the parking automatic emergency braking system fails, the warning light will be on.

start and drive



12V battery charging failure warning light: When the charging system fails, the warning light will be on.



Seat belt not fastened warning light : When the system detects that the driver's seat belt is not fastened, the warning light will be on. If the warning light stays on after the seat belt is fastened, it indicates a fault with the seat belt system.



Air suspension system failure warning light: When the performance of air suspension system components fails/temporarily weakens, the yellow warning light is on; when the air suspension system fails, the red warning light is on, and the system disables the air suspension system at the same time.





安全气囊故障警告灯：安全气囊系统或预紧器系统存在故障时，该警告灯点亮。



盲区监测系统故障警告灯：盲区监测系统出现故障时，该警告灯常亮。盲区监测系统标定未完成时，该警告灯闪烁



低速行人提示音功能故障警告灯：低速行人提示音功能故障时，该警告灯点亮

车身稳定控制系统

车身稳定控制系统可以在车辆出现转向过度或转向不足时，通过控制一个或多个车轮的制动分配，减小或消除转向过度或转向不足的现象，提高驾驶稳定性和安全性。

powertrain component malfunctions.

Powertra
in
Malfunc
ion
Warning
Light :
This
warning
light
comes on
when a

Lane



车身稳定控制系统状态指示灯：车身稳定控制系统存在故障，该警告灯常亮。车身稳定控制系统工作时该警告灯闪烁



前向碰撞减缓系统故障警告灯：前向碰撞减缓系统出现故障



电子驻车制动系统警告灯：电子驻车制动处于工作状态或出现故障时，该警告灯闪烁；电子驻车制动启用后，该警告灯点亮。

28

Keeping
Assist
Malfunction
Warning
Light:
Lane
Keeping
Assist
Malfunction

警告!

Vehicle Stability Control is an assistance system and cannot handle all situations or road conditions. It is always the driver's responsibility to operate the vehicle safely and prudently, and to obey the laws and traffic laws and regulations in force.

Never disassemble, remove or modify the vehicle suspension yourself. Otherwise, the vehicle stability control system may not operate properly and the vehicle's handling may be adversely affected.

警告!

When Vehicle Stability Control is switched off, less stability control is applied to the vehicle.

illustrate!

If the vehicle gets bogged down in snow, sand, or other conditions, turning off stability control can help the vehicle get out of trouble.

- You can turn on/off the vehicle stability control system through the central display screen, see the electronic version of the user manual for details.

**ABS**

The vehicle is equipped with an anti-lock braking system that prevents the wheels from locking up when you apply maximum braking force. Improves steering control of the vehicle in emergency braking situations in most road conditions.

Notice!

On rough, gravel, or water/snow-covered roads, braking distances will be longer than on normal roads.

illustrate!

During braking, you may feel a continuous "clack" sound from the engine room and vibrations from the brake pedal at the same time. This is a normal phenomenon caused by the operation of the anti-lock brake system, and it is not a malfunction.

When the brake anti-lock braking system stops working, the feel of the brake pedal will return to the state of non-anti-lock braking.

Description of functional status**Anti-lock braking system malfunction warning light :**

If this warning light comes on after the vehicle is started or while the vehicle is being driven, it indicates that there may be a malfunction in the anti-lock braking system.

Voltage Warning Labels for High Voltage Systems



h

high pressure system

Labels are attached to high voltage parts. Never touch, disassemble or replace these parts.

警告!

During the use of the vehicle, the high-voltage system may be in a state of high voltage and high temperature. Please follow the label instructions to avoid high voltage and high temperature damage.



Physical contact with high voltage components by yourself or rescue personnel should be strictly avoided. Rescuers should take all precautions (including wearing insulating clothing, insulating shoes, insulating gloves, etc.).

high pressure system

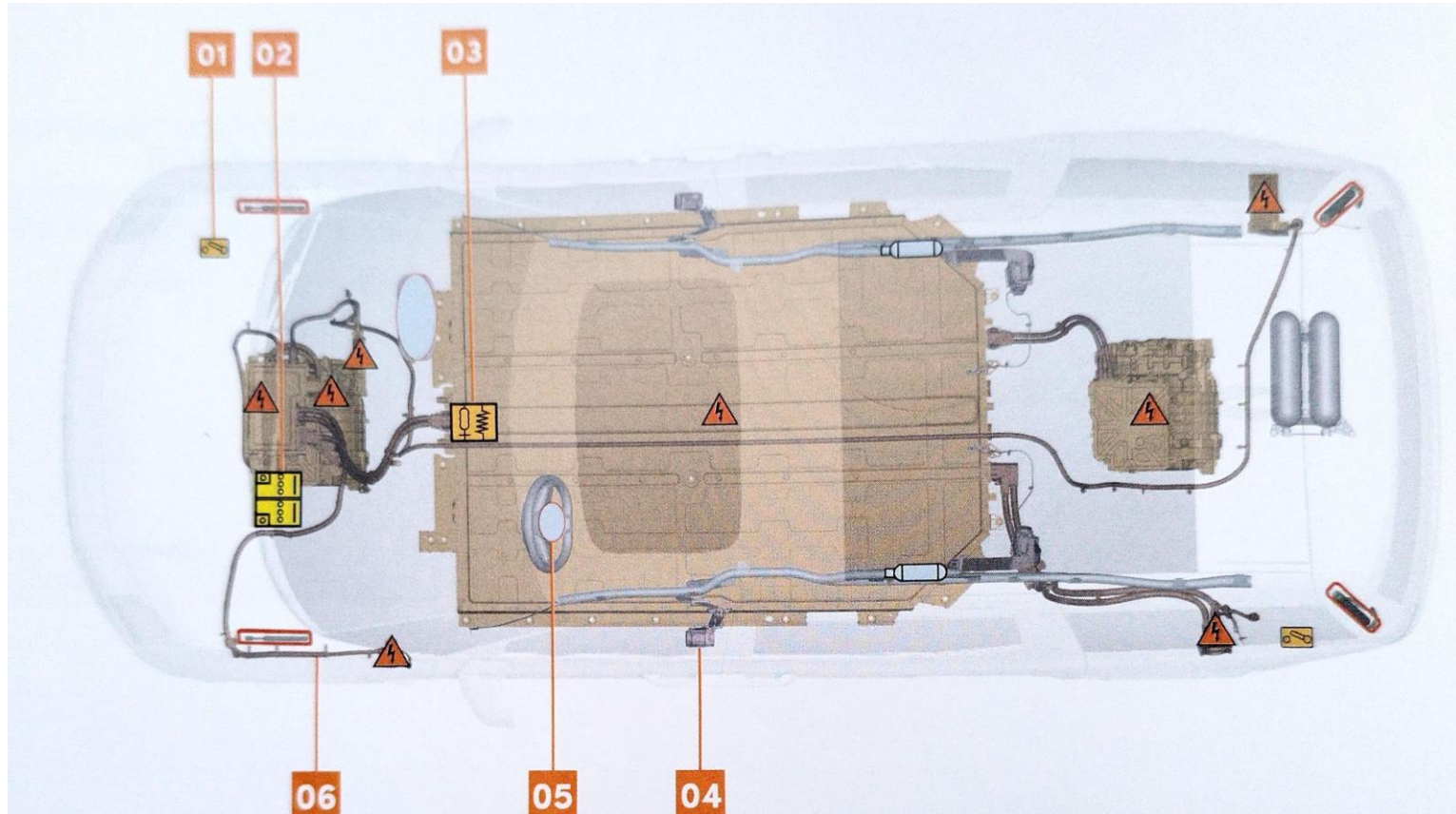
Emergency Rescue Information



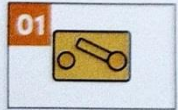
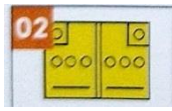
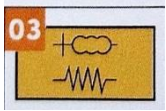
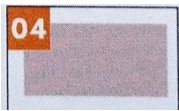
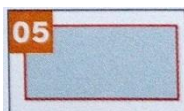



34

					
<p>Emergency thread trimmer</p>	<p>12V battery</p>	<p>airbag control unit</p>	<p>seat belt pretensioner</p>	<p>airbag</p>	<p>High voltage component wiring</p>

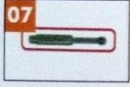
					harness
--	--	--	--	--	---------

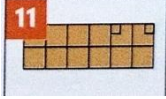
high pressure system

 <p>07</p>	<p>08</p>	<p>09</p>	 <p>10</p>	 <p>11</p>	 <p>12</p>
<p>strut</p>	<p>The gas generator</p>	<p>air suspension tank</p>	<p>Structural reinforcement</p>	<p>High voltage battery pack</p>	<p>High voltage electrical components</p>

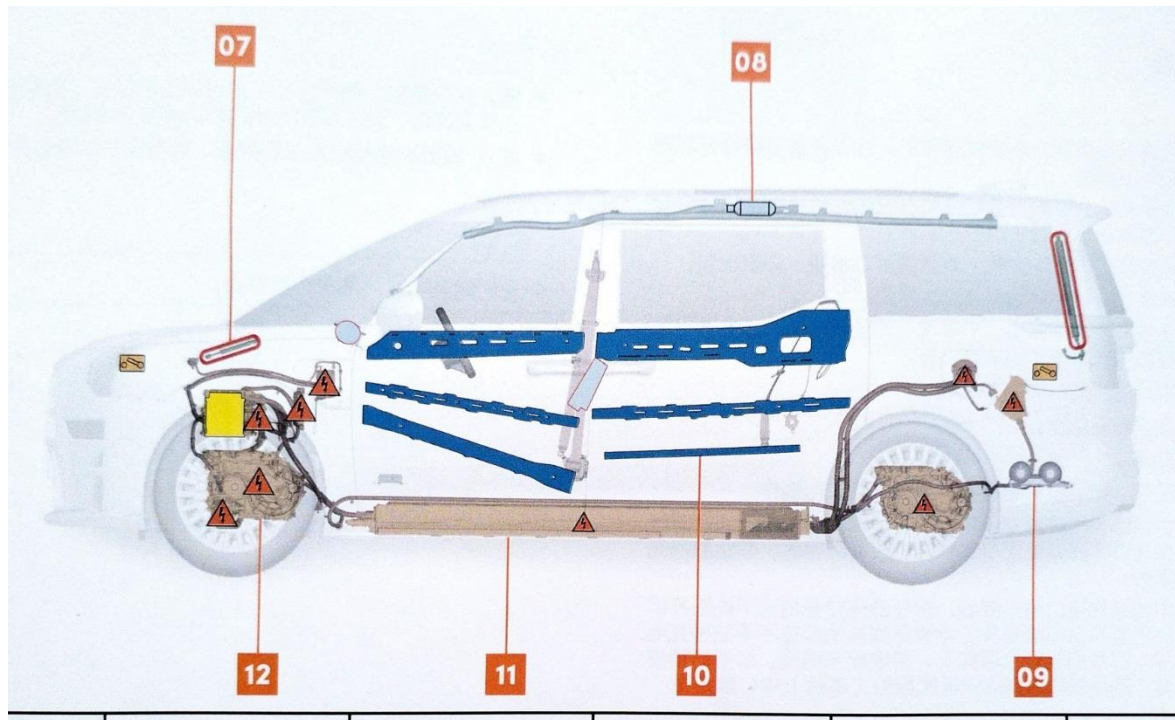

Charging Safety Warning



Please check the charging cable before charging, and it is forbidden to use the charging cable with damaged skin or shell or other hidden dangers of electric leakage.

Before charging, please make sure that there is no water or foreign objects in the charging port of the vehicle, power supply equipment and charging connection device, and that the metal terminals are not rusted or corroded.

Please charge in a relatively safe environment, avoid rain, flooding, and keep away from fire sources.

Do not disassemble or modify the charging device and related ports without permission.

Please choose a dry and ventilated charging environment. Do not use the charging device in an environment where gasoline, paint, flammable and explosive items are used or stored.

It is strictly forbidden to use the charging cable in dark and humid places.

Do not let children do charging work.

Never touch the charging port.

In rainy and snowy weather, if there is no canopy, please do not charge.

In case of sudden changes in the weather (gale, rain, snow, thunderstorm) during the charging process, you should check whether the charging plug is firm and in a dry state in time; when there is thunder and lightning, it is forbidden to touch the charging cable and the car body.

If the vicinity of the charging port is damp during charging, please disconnect the power supply first under the condition of ensuring safety, and then disconnect the plug of the power supply end (don't touch the metal sheet of the charging plug with your hands or other parts of your body, so as not to cause safety accidents), and then pull out. For the charging gun, please use insulating gloves if necessary, and contact the ZEEKR service (experience) center as soon as possible for testing and

confirmation.

If you notice a strange smell coming from the vehicle while charging, please stop charging immediately.

When charging, do not pinch the charging cable.

After charging, do not disconnect the charging connection device when your hands are wet or standing in standing water on the ground.

Before driving the vehicle, please ensure that the charging connection device has been disengaged from the charging port of the vehicle.

ⓘ 注意!

When inserting the charging cable, make sure that the locking device can return normally. When the locking device of the charging gun is working abnormally, please do not insert the charging gun into the charging socket of the vehicle.

When inserting/pulling out the charging cable, plug in and out at a constant speed, and do not tilt or shake the charging cable.
高压系统

illustrate!

When charging for a long time, please lock the vehicle.

of emergency



Emergency Rescue in an Emergency

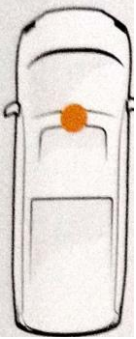

When there is no network or the vehicle cannot supply power, the emergency rescue function (SOS call, remote anti-theft, vehicle tracking, etc.) cannot be used.

Emergency unlocking and locking of doors

Emergency unlocking outside the car

If you cannot unlock the door normally due to low-voltage battery loss, you can consult the ZEEKR service (experience) center for help.

emergency opening tailgate

In an emergency, you can use mechanical means to emergency open the tailgate from inside the vehicle.

- 1 Fold the backrests of the rear seats and access the trunk.
- 2 Press the buckle of the protective cover and remove the

Manual SOS call

Press and hold the SOS touch button for 2-8 seconds and let go to manually activate the SOS function. Note that if the pressing time is lower than 2 seconds or higher than 8 seconds, SOS will not be dialed out.

protective cover.

After the SOS function is activated, passengers can directly seek emergency assistance from ZEEKR partners, and the vehicle location will be sent to ZEEKR partners. ZEEKR partners will provide appropriate assistance (call ambulance, police, etc.) depending on the situation.

Automatic SOS call

When any airbag or emergency crash sensor of the vehicle is triggered, the SOS function is automatically activated and sends a signal to the ZEEKR partner. ZEEKR partners will provide appropriate assistance (call ambulance, police, etc.) depending on the situation.



emergency opening sliding door

In an emergency, if the power sliding door cannot be opened normally, you can manually open the sliding door from inside the vehicle.

1 Turn on the emergency lock switch of the sliding door to unlock the sliding door.

2 Pull the inward opening handle firmly to the rear to open the sliding door.

3 沿箭头方向滑动控制杆，解锁尾门。

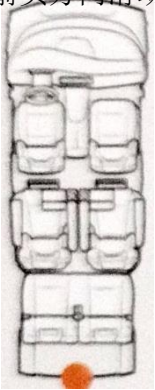

emergency lock door

When the doors cannot be locked normally, you can lock the doors with the emergency locking device.

Front door emergency locking device

1 Turn the front door emergency lock switch in the direction of the indicated arrow, close the front door, and lock the front door.

4. Push outward to open the tailgate.

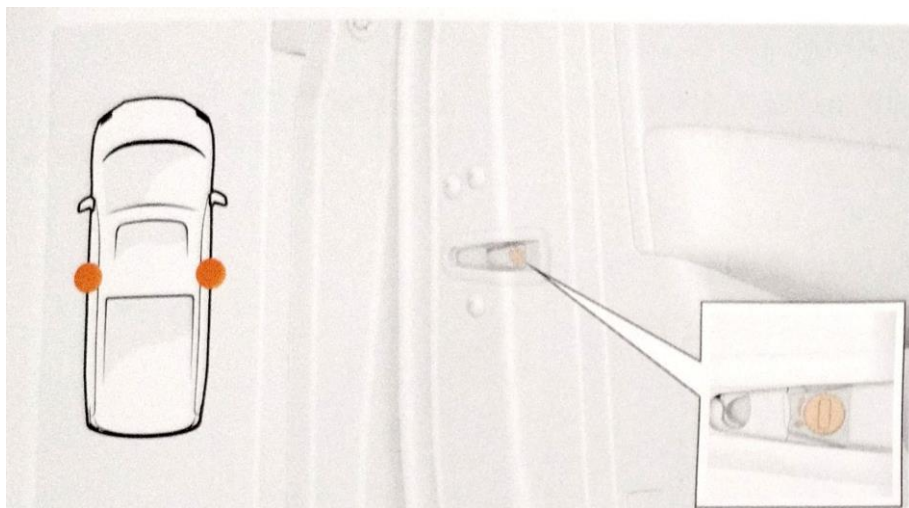

Emergency unlock charging gun

When the charging gun in the front charging port cannot be pulled out due to unexpected situations (such as vehicle power failure, electronic lock mechanical failure) when the vehicle is charging, you can manually unlock the charging gun through the emergency unlocking cable. The emergency release cable is located at the left front wheel cover, which can be seen by opening the emergency release cable cover on the wheel cover.

1 Twist and remove the emergency release cable access cover.

Sliding door emergency locking device

1 Turn off the sliding door lock switch, close the sliding door, and lock the sliding door.

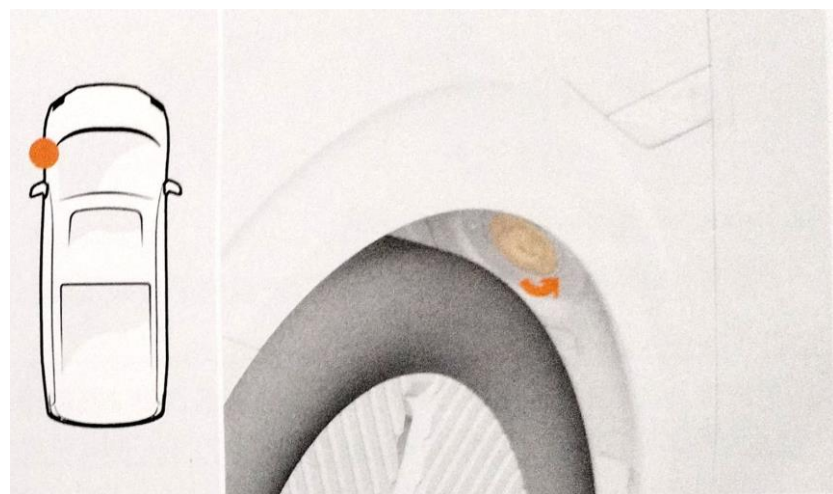

2 Pull the emergency release cable.

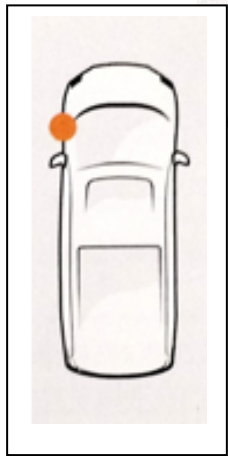

3 Press the charging gun unlock button and pull out the charging gun.

4 Reinstall the emergency release cable access cover.

说明!

□ If you still cannot unlock the charging gun after trying the above methods, please contact the ZEEKR service (experience) center for help.

Emergency unlock charging port cover

When the vehicle is ready to charge, emergencies occur (such as the vehicle's power failure, electronic lock mechanical failure of the electric port cover).

Emergency unlock slow charging cover

1 Twist and remove the emergency release cable access cover.

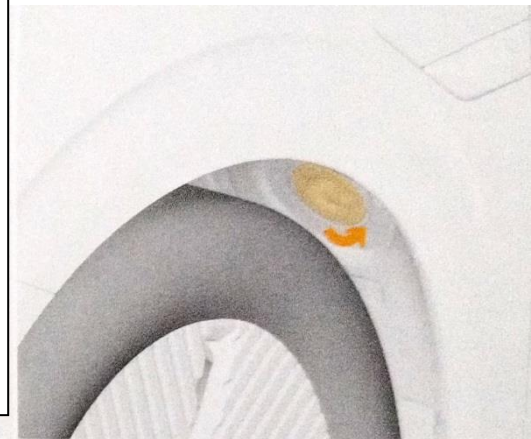
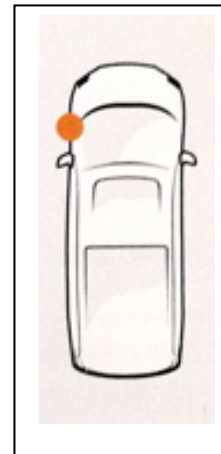

2 Pull the emergency release cable to open the slow charging cover.

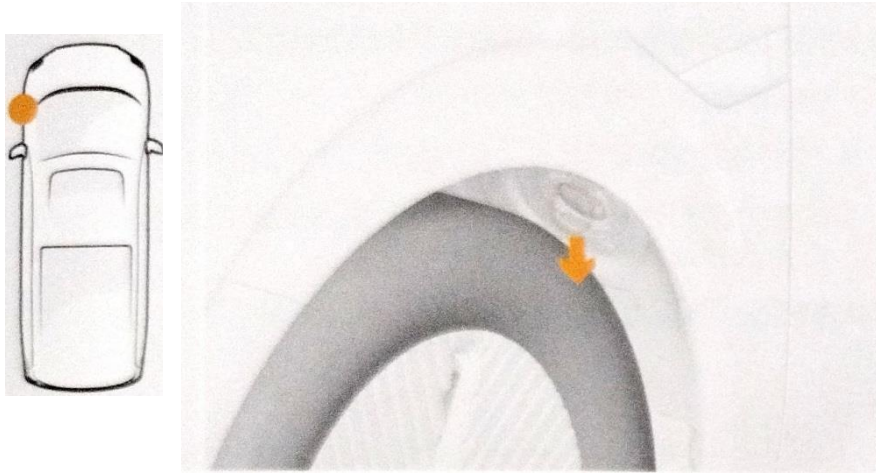

3Reinstall the emergency release cable access cover.

Emergency unlock fast charging cover

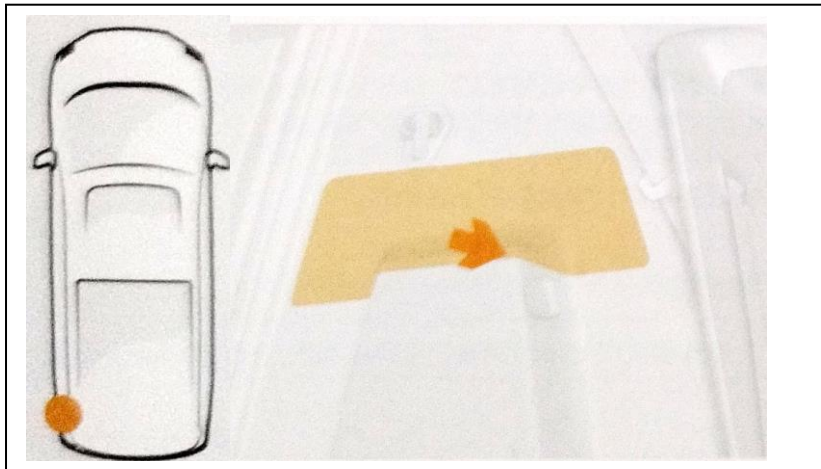

1 Remove the left emergency cover of the trunk.



2. Pull the emergency release cable to open the fast charging cover.
3Restore the emergency release cable to the fixed position, and reinstall the left emergency cover of the trunk.

①Explanation!

- 快充盖和慢充盖为电动打开 / 关闭，请勿用力挤压或拖拽充电口盖。
- 若尝试上述方法还是无法打开充电口盖，请联系 ZEEKR 极氪服务 (体验)中心寻求帮助。

towing vehicle

traction method

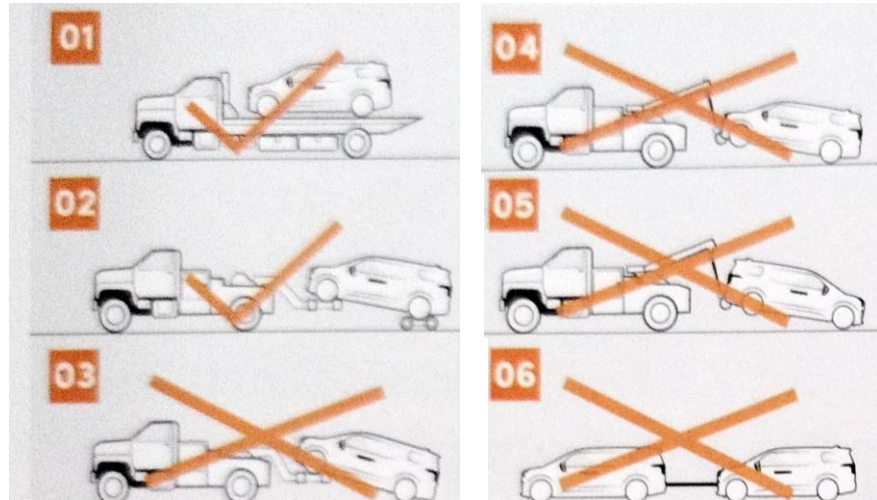

01

01 Place the vehicle on a flatbed trailer - the recommended way.

02 Vehicle with front wheels raised and rear wheels placed on a small trailer (off the ground) - recommended.

03 Traction with the rear wheels rolling forward - the wrong way.

04 Lift the front body/chassis section, not the wheels - the wrong way.

05 Lift the rear body/chassis section, not the wheels - the wrong way.

06 Rigid dragging - the wrong way.

enter trailer mode

Before towing the vehicle to a flatbed trailer, put the vehicle into trailer mode:

- 1 Make sure the key is in the car.
- 2 Open and close the main driving door once.
3. Press and hold the hazard warning light switch for more than 7 seconds until the warning light on the meter self-checks (the warning light lights up and goes out after a few seconds) once.
- 4 Shift the gear to neutral (N) and release the parking brake.

warn!

Do not allow any person or object to be behind the trailer while the vehicle is being towed to it.

After the vehicle is towed to a flatbed trailer, to ensure the safety of parking the vehicle, please exit the trailer mode and activate the Electronic Parking Brake (EPB).

Passengers are prohibited from remaining in the vehicle while the vehicle is being towed.

Notice!

The vehicle must be in trailer mode before it can be towed to a flatbed trailer.

ZEEKR recommends using a flatbed trailer to tow the vehicle. When towing, all four wheels must be off the ground.

During transport, make sure that the wheels cannot turn.

①Explanation!

Trailer mode is only used for towing the vehicle to a flatbed

foreword

trailer.

exit trailer mode

You can exit trailer mode in any of the following ways:

- 1 Shift the gear into Park (P) and lock the vehicle from the outside.
- 2 Shift the gear to forward gear (D) or reverse gear (R) to enter a new driving journey.

use tow eye

The vehicle is equipped with a towing ring, which can assist the flatbed trailer to tow the vehicle to a safe area in case of emergency or breakdown, see the electronic version of the user manual for details.

Safety vest and warning triangle

In the event of an emergency or breakdown that leaves the vehicle stranded in traffic, you should place a warning triangle at a suitable location to warn other road users, and wear a safety vest to ensure personal safety.

Relevant local requirements for the use of safety vests and warning triangles should be followed.

safety vest

The safety vest is placed in the glove box. Wearing the safety vest can increase visibility and help reduce the risk of secondary accidents. If you make an emergency stop in traffic, put on your safety vest before getting out of the vehicle.

紧急情况

Triangle warning sign

The vehicle is equipped with a warning triangle. Take out the warning triangle and unfold it and place it in an appropriate position behind your car to warn other road users. For details, please refer to the electronic version of the user manual.

technical information

vehicle identification

nameplate

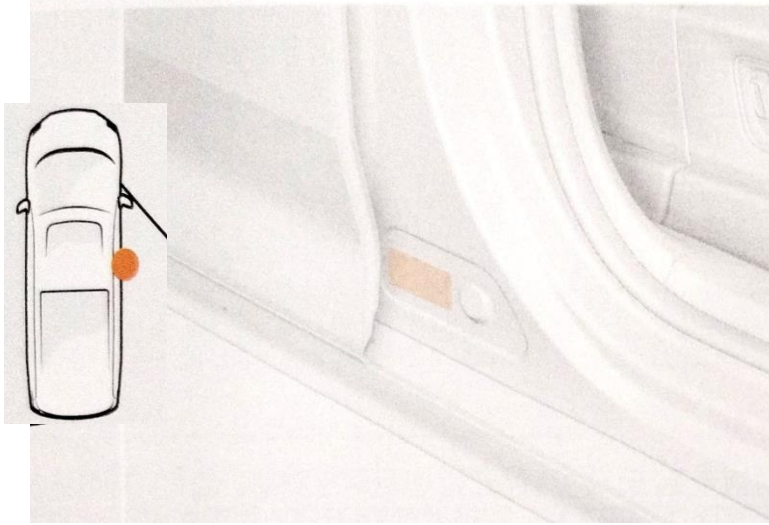

This label contains information such as the vehicle make, vehicle identification number, and more.

Vehicle Identification Number (VIN)

The Vehicle Identification Number (VIN) is the legal identification of a vehicle.

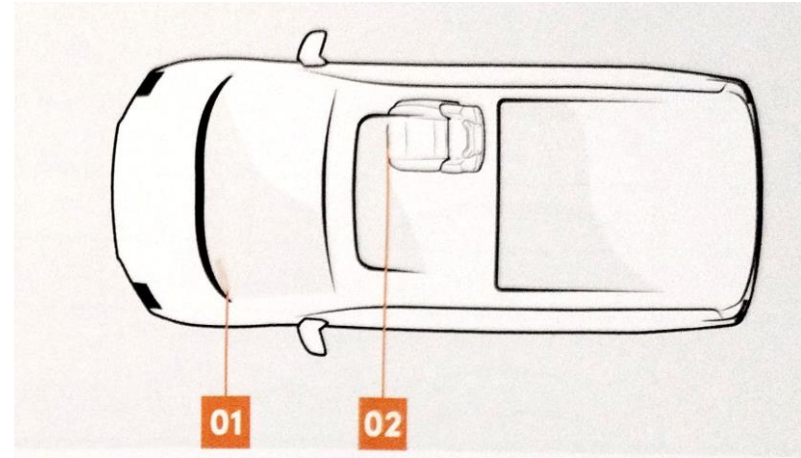

01

The VIN is located in the lower left corner of the windshield.

02 VIN on front passenger seat beam.

Notice!

Do not scratch, remove, cover, hide, alter, or paint the Vehicle Identification Number (VIN). Please keep labels visible and legible.

microwave window

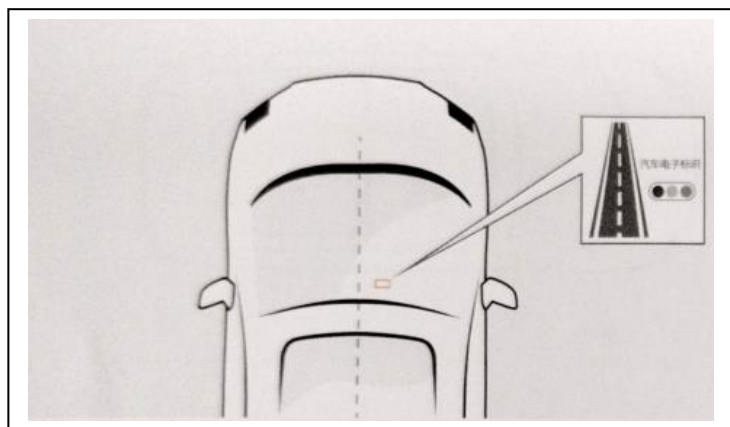

The microwave window of the vehicle is located in the horizontal center of the windshield glass and vertically upper.

The automotive electronic identification should be installed in the middle right of the microwave window. It cannot be blocked by the interior rearview mirror mounting bracket, sensor bracket, etc.

Notice!

Do not cover, squeeze or dismantle the car electronic identification.

If the logo is damaged, please go to the logo issuing agency to reapply in time.

illustrate!

☐ Please keep the windshield clean and dry; do not paste film or metal materials on the microwave window, to ensure the standardized

installation of the automotive electronic signs and the effective reading of data.

50

tire pressure label

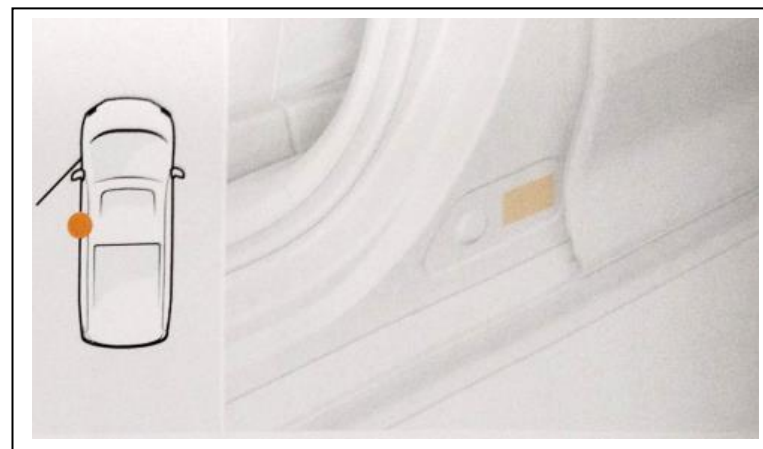

Check your tire pressure often, especially before starting a long drive. You can find the recommended tire pressure specifications in the technical data section of the tire pressure label (located on the driver's side B-pillar).

Under- or over-inflation may adversely affect tire life and vehicle handling, resulting in loss of vehicle control.

To meet strict vehicle stability and handling requirements, please install the wheels/tyres recommended by ZEEKR. Damage

caused by fitting unsuitable wheels/tyres will not be covered under your vehicle warranty. ZEEKR disclaims all liability for personal injury, vehicle damage, or other property loss resulting from such installations.

Technical
Information

rearview mirrors.

(b): The measured height contains the multi-band antenna.

(c): Single chamber air suspension.

(d): 19-inch tires with dual-chamber air suspension.

(e): 20-inch tires with dual-chamber air suspension.

Notice!

After inflating the tires, be sure to reinstall the valve dust caps to prevent dust, gravel, etc. from damaging the valves. Use only plastic valve shields, as metal valve shields are difficult to remove once rusted.

vehicle parameters

Vehicle Dimensional Parameters (Curb Weight)

size	unit (mm)
length	5209
Vehicle width (.)	2024
height (b)	1856(c)/1858(d)/1864(e)

(o): The measured width is the vehicle width excluding the exterior

car weight

car model	curb weight (kg)	Maximum Allowable Gross Weight Amount (kg)
MR6525BEV04	2830	3320
MR6525BEV05	2830	3320
MR6525BEV06	2906	3400

Vehicle axle load (maximum allowable total mass state)

car model	front axle maximum axle load (kg)	Rear axle maximum axle load (kg)
MR6525BEV04	1491	1829
MR6525BEV05	1491	1829
MR6525BEV06	1529	1871

Tire specifications

Tire Size/Type
255/50 R19
265/45 R20

